

MINI JACK DOUBLE

P90



REMAX DU CARTIER, MONTRÉAL QC
DESIGN: LISE GAGNON
PHOTO: SARAH DAGENAIS, 2019

©2025 Arancia Lighting

We reserve the right to change our products designs and specifications • Nous nous réservons le droit de modifier le design ainsi que les spécifications de nos produits.

DESIGNED + MADE IN CANADA

ARANCIALIGHTING.COM



ARANCIA.

MINI JACK DOUBLE

P90



DESIGNED + MANUFACTURED BY ARANCIA LIGHTING

MINI JACK DOUBLE

P90



Extruded aluminum linear lighting system that can be specified in a variety of lengths. An extruded impact resistant frosted acrylic lens provides a diffused glow. Dimming version available.

Système d'éclairage linéaire fait d'aluminium extrudé et disponible en plusieurs formats. Une lentille en acrylique givrée résistant aux chocs diffuse la lumière uniformément. Option de gradation disponible.

POWER CLASS CATÉGORIE DE PUISSANCE	* LIGHT OUTPUT RENDU LUMI- NEUX	* EFFICACY EFFICACITÉ	* POWER PUISSANCE
A	1 794 lm/FT	150 lm/W	12 W/FT
B	1 155 lm/FT	150 lm/W	7.7 W/FT
C	645 lm/FT	150 lm/W	4.3 W/FT

* DATA PER DIRECTION OF LIGHT • DONNÉES PAR DIRECTION DE LUMIÈRE



2700 K
3000 K
3500 K
4000 K



0-10 V
TRIAC
ECOSYSTEM
HI-LUME



MINI JACK DOUBLE

P90

PROJECT	DATE
NOTE	TYPE

PRODUCT CODE • CODE DE PRODUIT

P90			
-----	--	--	--

MODEL MODÈLE	MODULES SEQUENCE SÉQUENCE DE MODULES	LIGHT SOURCE SOURCE LUMINEUSE	INDIRECT REFLECTOR OPTION OPTION DE RÉFLECTEUR INDIRECT	INDIRECT POWER CLASS CATÉGORIE DE PUISSANCE INDIRECTE
P90 MINI JACK DOUBLE	-2 24" • 610 mm -3 36" • 914mm -4 48" • 1220 mm -5 60" • 1524 mm -6 72" • 1828 mm -7 84" • 2133 mm -8 96" • 2438 mm -XX CUSTOM DIMENSION LENGTH ² • -SXX ¹ LONGUEUR D'APPAREIL SUR MESURE	-C LED • DEL • 4000K 90 CRI -N LED • DEL • 3500K 90 CRI -W LED • DEL • 3000K 90 CRI -I LED • DEL • 2700K 90 CRI -T ² LUTRON T-SERIES DIGITAL 2-CHANNEL TUNABLE WHITE SÉRIE-T DE LUTRON LUMIÈRE BLANCHE RÉGLABLE 2-CANNAUX	-R REGRESSED 105° BEAM EN RETRAIT FAISCEAU 105° -B BATWING WIDE BEAM -RM REGRESSED MINI LENS LENTILLE EN RETRAIT MINCE	-O NONE • AUCUNE -A 1794 lm/FT (lm/PI) -B 1155 lm/FT (lm/PI) -C 645 lm/FT (lm/PI) SPECIFY CUSTOM lm/FT -X SPÉCIFIER lm/PI PERSONNALISÉ

¹ CUTTABLE AT EVERY 1". REFER TO SYSTEMS GUIDE TO DETERMINE OVERALL SYSTEM DIMENSIONS • PEUT ÊTRE COUPÉ À TOUS LES 25.4mm. SE RÉFÉRER AU GUIDE DES SYSTÈMES POUR DÉTERMINER LES DIMENSIONS HORS-TOU DU SYSTÈME.

² CONSULT FACTORY FOR AVAILABILITY, PRICE AND DELAY • CONSULTER L'USINE POUR DISPONIBILITÉ, PRIX ET DÉLAIS

* INDIVIDUAL FIXTURES CANNOT BE FIELD JOINED • LES APPAREILS INDIVIDUELS NE SONT PAS JOIGNABLES IN SITU.

--	--	--	--	--

DIRECT REFLECTOR OPTION OPTION DE RÉFLECTEUR DIRECT	DIRECT POWER CLASS CATÉGORIE DE PUISSANCE DIRECTE	# CIRCUITS	VOLTAGE VOLTAGE	DIMMING SPECIFICATION OPTION DE GRADATION
-R REGRESSED 105° BEAM EN RETRAIT FAISCEAU 105°	-O NONE • AUCUNE -A 1794 lm/FT (lm/PI) -B 1155 lm/FT (lm/PI) -C 645 lm/FT (lm/PI) -X SPECIFY CUSTOM lm/FT SPÉCIFIER lm/PI	-1 1 CIRCUIT -2 2 CIRCUITS -E EMERGENCY CIRCUIT • CIRCUIT D'URGENCE -B ³ EMERGENCY BATTERY PACK • MODULE DE BATTERIE D'URGENCE -G GENERATOR TRANSFER DEVICE • DISPOSITIF DE TRANSFERT DE GÉNÉRATEUR	-U 120 - 277V -1 120V -3 347V	-O 0-10V LED DIMMING GRADATION DEL 0-10V -T TRIAC LED DIMMING GRADATION DEL TRIAC -LD2 LUTRON DALI2 LED DIMMING 1% • GRADATION 1% DEL DALI2 -LDE1 LUTRON HI-LUME 1% ECOSYSTEM LED DRIVER WITH SOFT-ON LUTRON HI-LUME 1% PILOTE DEL ÉCOSYSTÈME AVEC ALLUMAGE-DOUX -E1 ELDOLED ECOdrive 0-10V LED DIMMING 1% • GRADATION 1% ECOdrive 0-10V -E0 ELDOLED SOLOdrive 0-10V LED DIMMING 0.1% • GRADATION 0.1% SOLOdrive 0-10V
-LV ANTI-GLAIR LOUVERS LOUVER ANTI-ÉBLOUISSEMENT				
-RM REGRESSED MINI LENS LENTILLE EN RETRAIT MINCE				
-LN ² MULTI-LENSES BEAM 30° LENTILLES MULTIPLES 30°				
-LW ² MULTI-LENSES BEAM 80° LENTILLES MULTIPLES 80°				
-LA ² MULTI-LENSES ASYMMETRIC BEAM LENTILLE MULTIPLES ASYMÉTRIQUE				
-LS ² MULTI-LENSES WALL WASH LENTILLE MULTIPLES POUR ALLÉES				
-S13 MODULE OF 4 SPOTS 13° BEAM MODULE DE 4 ENCASTRÉS FAISCEAU 13°				
-S29 MODULE OF 4 SPOTS 29° BEAM MODULE DE 4 ENCASTRÉS FAISCEAU 29°				
-S61 MODULE OF 4 SPOTS 61° BEAM MODULE DE 4 ENCASTRÉS FAISCEAU 61°				
-SO MODULE OF 4 SPOTS OVAL BEAM MODULE DE 4 ENCASTRÉS FAISCEAU OVAL				

³ SPOT MODULES HAVE A SET OUTPUT OF 10W 1000lm • LES MODULES D'ENCASTRÉS ONT UN RENDEMENT DE 10W 1000lm

⁴ ONLY AVAILABLE IN STRAIGHT SECTIONS UP TO 5 FEET, SPECIFY POSITION OF EM CIRCUIT • SEULEMENT DISPONIBLE EN SECTIONS DROITES JUSQU'À 5 PIEDS, SPÉCIFIER LA POSITION DU CIRCUIT D'URGENCE

--	--	--

MOUNTING OPTION OPTION DE MONTAGE	STRUCTURE FINISH FINI DE STRUCTURE	OPTICS FINISH FINI D'OPTIQUES
-SC DRYWALL, 60" AIRCRAFT CABLE GYPSE, CÂBLES DE SUSPENSION 1524mm	BK BLACK • NOIR -WH WHITE RAL 9003 • BLANC -MG METALLIC GREY • GRIS MÉTALLIQUE	-BK BLACK • NOIR -WH WHITE RAL 9003 • BLANC -MG METALLIC GREY • GRIS MÉTALLIQUE
-T5 15/16" SUSPENDED CEILING GRID T-BAR BARRES EN T 15/16" PLAFOND SUSPENDU		
-T9 9/16" SUSPENDED CEILING GRID T-BAR BARRES EN T 9/16" PLAFOND SUSPENDU		
-ST 36" STEM • TIGE DE 914mm		
	-BL BLUE RAL 5005 • BLEU -GN GREEN RAL 6017 • VERT -RD RED RAL 3002 • ROUGE -YL YELLOW RAL 1003 • JAUNE -OG ORANGE RAL 2004 • ORANGE -PB PEARL BEIGE RAL 1035 • BEIGE NACRÉ -PG PEARL GOLD RAL 1035 • OR NACRÉ -SP CUSTOM, SPECIFY RAL COLOR SUR MESURE, INDIQUER COULEUR RAL	-BL BLUE RAL 5005 • BLEU -GN GREEN RAL 6017 • VERT -RD RED RAL 3002 • ROUGE -YL YELLOW RAL 1003 • JAUNE -OG ORANGE RAL 2004 • ORANGE -PB PEARL BEIGE RAL 1035 • BEIGE NACRÉ -PG PEARL GOLD RAL 1035 • OR NACRÉ -SP CUSTOM, SPECIFY RAL COLOR SUR MESURE, INDIQUER COULEUR RAL

-CR⁶ CHROME MULTI-LENS REFLECTOR • RÉFLECTEUR DE LENTILLES MULTIPLES CHROME



2700 K
3000 K
3500 K
4000 K



0-10 V
TRIAC
ECOSYSTEM
HI-LUME



MINI JACK DOUBLE

YP90 CUSTOM SYSTEM • YP90 SYSTÈMES SUR MESURE

The Mini Jack Double can be assembled in various layouts using different corner options. A custom layout can be provided with a shop drawing, which will be completed within 5 days.

Le mini jack double peut être assemblé dans divers agencements en utilisant différentes options d'angle. Un agencement personnalisé peut être réalisé à partir d'un plan d'atelier, livré dans un délai de 5 jours.

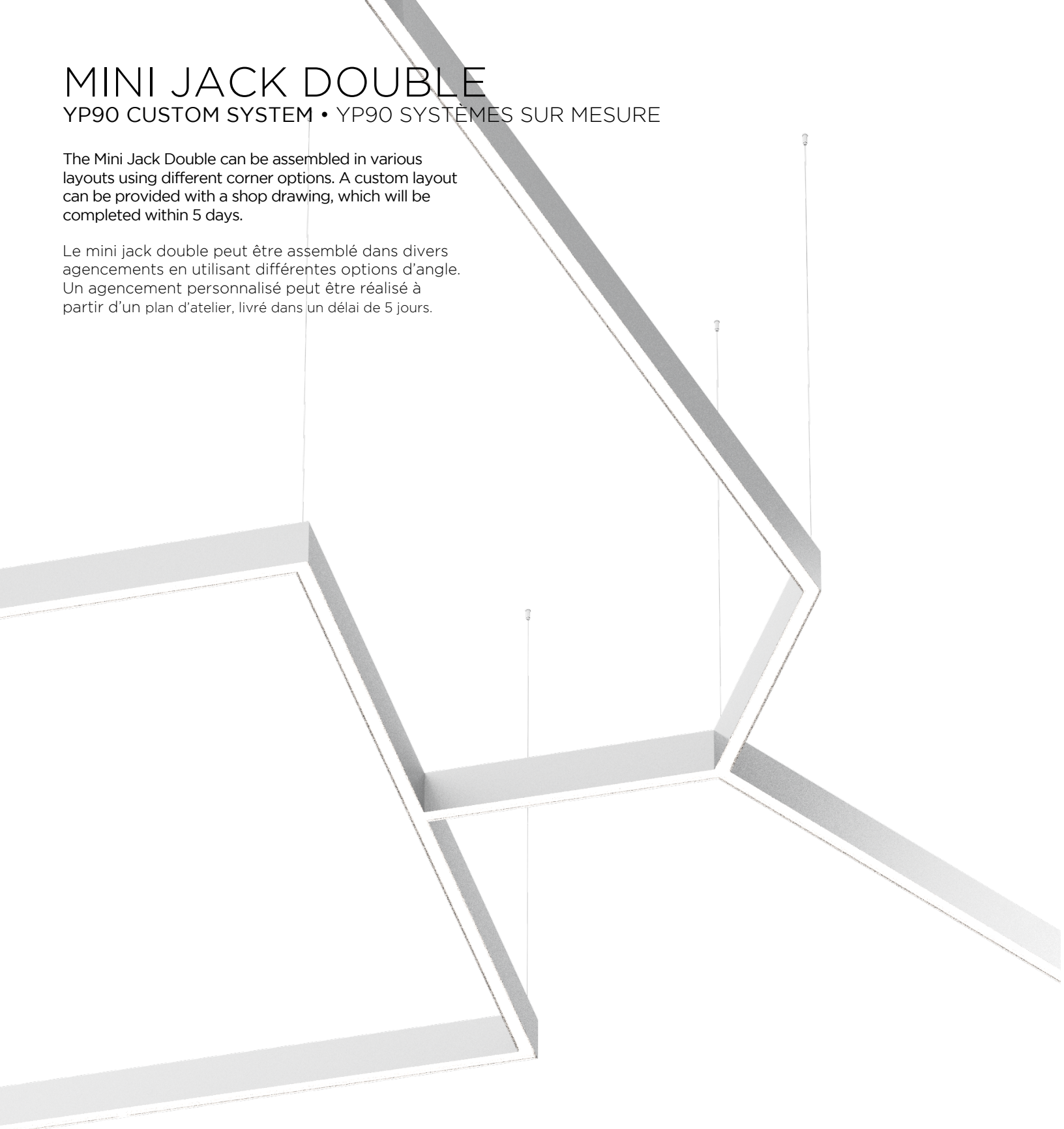

MINI JACK DOUBLE

P90 FEATURES • P90 CARACTÉRISTIQUES
PHOTOMETRICS LENSES • PHOTOMÉTRIE LENTILLES

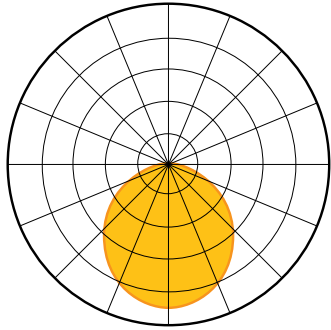

REGRESSED, 105° BEAM
EN RETRAIT, FAISCEAU DE 105°

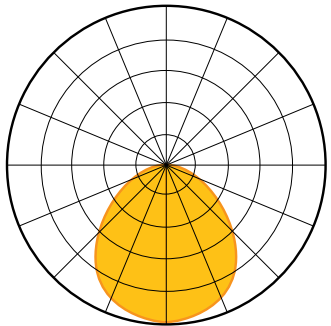
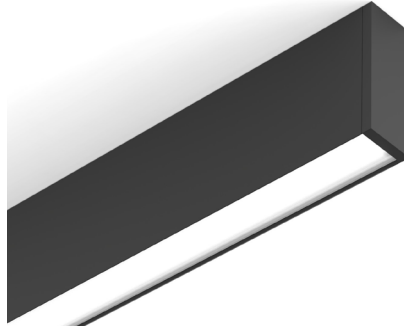

REGRESSED MINI, DIRECT BEAM
EN RETRAIT MINCE, FAISCEAU DIRECT

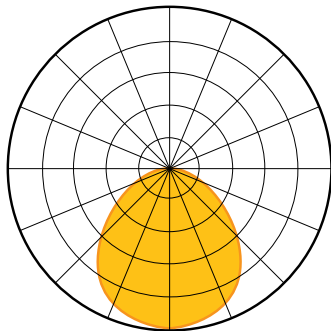
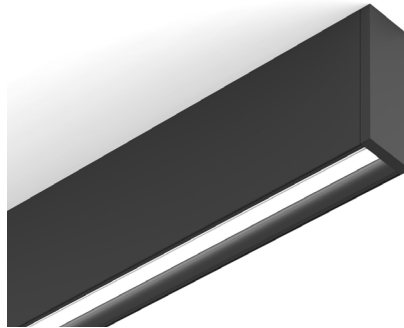

ANTI-GLAIR LOUVERS
AILETTES ANTI-ÉBLOUISSEMENT

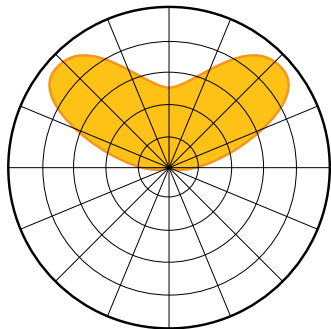
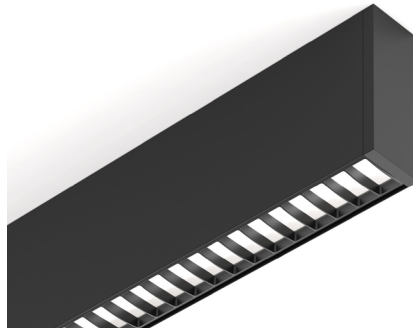

BATWING INDIRECT BEAM
FAISCEAU BATWING INDIRECT

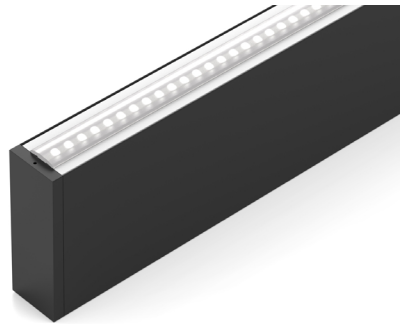

MINI JACK DOUBLE

P90 FEATURES • P90 CARACTÉRISTIQUES

PHOTOMETRICS MULTI-LENSES • PHOTOMÉTRIE LENTILLES MULTIPLES

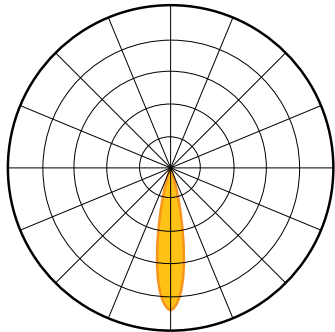

NARROW 30° BEAM
FAISCEAU ÉTROIT 30°

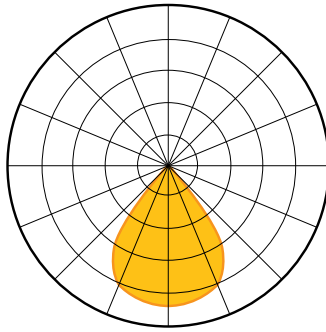

WIDE 80° BEAM
FAISCEAU LARGE 80°

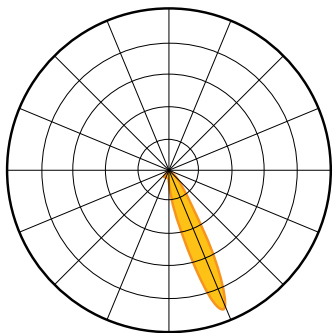
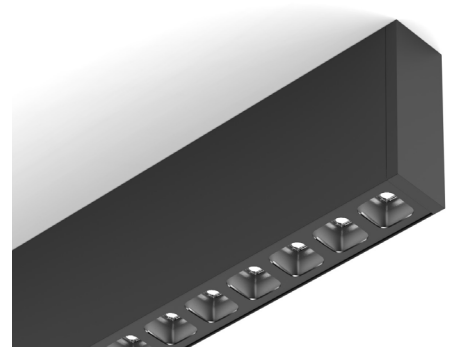

ASYMMETRIC BEAM
FAISCEAU ASYMÉTRIQUE

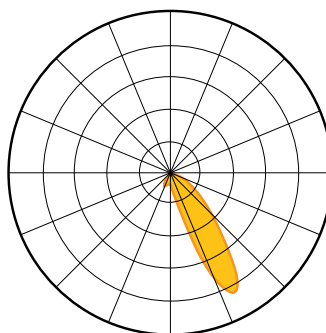

WALL WASHER
FAISCEAU POUR ALLÉES

PHOTOMETRICS SPOTS • PHOTOMÉTRIE ENCASTRÉS

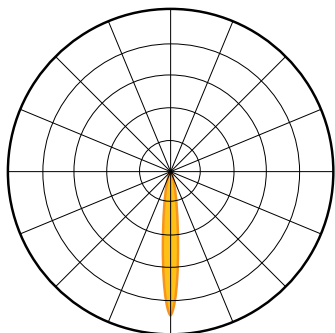

SPOT 13° BEAM
ENCASTRÉ FAISCEAU DE 13°

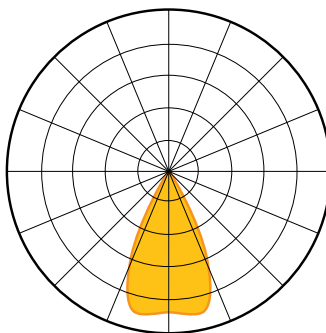

SPOT 61° BEAM
ENCASTRÉ FAISCEAU DE 61°

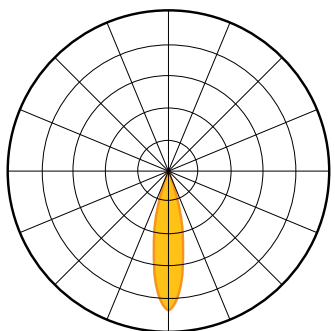
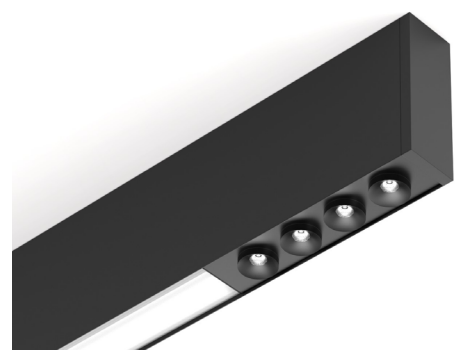

SPOT 29° BEAM
ENCASTRÉ FAISCEAU DE 29°

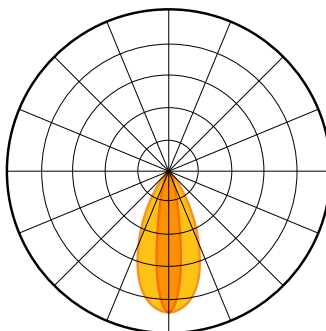

SPOT OVAL 45° + 15° BEAM
ENCASTRÉ FAISCEAU OVALE DE 45° + 15°



MINI JACK DOUBLE

P90 STANDALONE UNIT GUIDE • P90 GUIDE DES APPAREIL INDIVIDUELS

POWER AND CURRENT • PUISSANCE ET COURANT ÉLECTRIQUE

CODE	ELECTRICAL POWER CLASS CATÉGORIE DE PUISSANCE ÉLECTRIQUE					
	DIRECT LIGHT ÉCLAIRAGE DIRECTE			INDIRECT LIGHT ÉCLAIRAGE INDIRECTE		
	A	B	C	A	B	C
-2	24W 3 588 lm	16W 2 392 lm	9W 1 346 lm	24W 3 588 lm	16W 2 392 lm	9W 1 346 lm
-3	36W 5 382 lm	24W 3 588 lm	13W 1 944 lm	36W 5 382 lm	24W 3 588 lm	13W 1 944 lm
-4	48W 7 176 lm	32W 4 784 lm	17W 2 542 lm	48W 7 176 lm	32W 4 784 lm	17W 2 542 lm
-5	60W 8 970 lm	39W 5 831 lm	22W 3 289 lm	60W 8 970 lm	39W 5 831 lm	22W 3 289 lm
-6	72W 10 764 lm	48W 7 176 lm	26W 3 887 lm	72W 10 764 lm	48W 7 176 lm	26W 3 887 lm
-7	84W 12 588 lm	54W 8 073 lm	30W 4 485 lm	84W 12 588 lm	54W 8 073 lm	30W 4 485 lm
-8	96W 14 352 lm	62W 9 269 lm	34W 5 083 lm	96W 14 352 lm	62W 9 269 lm	34W 5 083 lm

LUMEN OUTPUT AND WATTAGE CALCULATED WITH REGRESSED LENS AND STANDARD POWER CLASS • RENDU LUMINEUX ET WATTAGE EN CALCULÉS AVEC LENTILLE EN RETRAIT ET SORTIE LUMEN STANDARD

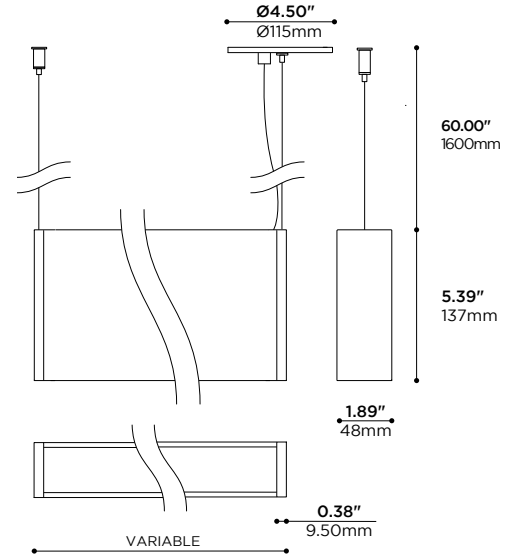

CODE	LENGTHS LONGUEURS			
	T OVERALL HORS TOUT	E ENDCAP THICKNESS ÉPAISSEUR EMBOUTS	L LIT SECTION SECTION ALLUMÉE	S MOUNTING POINTS POINTS D'ANCRAGE
-2	24" 626mm	0.38" 9.50mm	23.25" 607mm	23.68" 618mm
-3	36" 926mm		35.25" 909mm	35.68" 919mm
-4	48" 1229mm		47.25" 1210mm	47.68" 1221mm
-5	60" 1532mm		59.25" 1513mm	59.68" 1524mm
-6	72" 1833mm		71.25" 1814mm	71.68" 1825mm
-7	84" 2135mm		83.25" 2116mm	83.68" 2127mm
-8	96" 2437mm		95.25" 2418mm	95.68" 2429mm

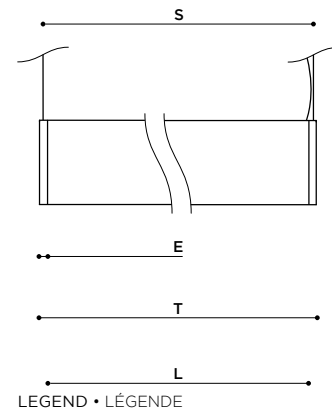

MINI JACK DOUBLE

P90 SYSTEM GUIDE • P90 GUIDE DE SYSTÈMES

MINI JACK LINEAR SYSTEMS ARE MADE OF SEVERAL UNITS PUT TOGETHER, ONE AFTER ANOTHER. TABLE BELOW SHOWS COMPOSITION OF SYSTEMS FROM 9 FEET TO 48 FEET. MINI JACK DOUBLE OFFERS A CONTINUOUS LENS FOR DIRECT LIGHT SOURCE, CREATING A CONTINUOUS LINE, NO MATTER HOW LONG YOUR SYSTEM IS.

LES SYSTÈMES LINÉAIRES MINI JACK SONT COMPOSÉS DE PLUSIEURS UNITÉS, MISES ENSEMBLE LES UNES À LA SUITE DES AUTRES. LE TABLEAU CI-DESSOUS MONTRÉ LA COMPOSITION DES SYSTÈMES ALLANT DE 9 PIEDS À 48 PIEDS. LES COMPOSITIONS SONT FAITES DE SORTE QUE LES SYSTÈMES APPARAÎSSENT LE PLUS UNIFORME POSSIBLE. LE MINI JACK DOUBLE OFFRE UNE LENTILLE CONTINUE POUR LA SOURCE D'ÉCLAIRAGE DIRECTE, CE CI PERMET À LA LUMIÈRE D'APPARAÎTRE COMME UNE SIMPLE LIGNE CONTINUE, PEU IMPORTE LA LONGUEUR DE VOTRE SYSTÈME.

TO GET SUSPENSION DISTANCES FOR EACH UNITS OF A SYSTEM, REFER TO STANDALONE TABLE (SEE PREVIOUS PAGE) AND ADD SUSPENSION DISTANCES ACCORDINGLY TO YOUR SYSTEM COMPOSITION. EXAMPLE: DEPICTED SYSTEM IS A 20 FEET MADE OF 7'+6'+7', SUSPENSION DISTANCE WILL BE: 83.7"+71.9"+83.7"

POUR OBTENIR LES DISTANCES DE SUSPENSION DE CHAQUE UNITÉS D'UN SYSTÈME, SE RÉFÉRER AU TABLEAU DES UNITÉS INDIVIDUELLES (VOIR PAGE PRÉCÉDENTE) ET ADDITIONNER LES DISTANCES DU SUSPENSION SELON LA COMPOSITION DU SYSTÈME. EXEMPLE: LE SYSTÈME ILLUSTRÉ EST UN 20 PIEDS, FAIT DE 7'+6'+7', LES DISTANCES DE SUSPENSIONS VONT ÊTRE: 83.7"+71.9"+83.7".

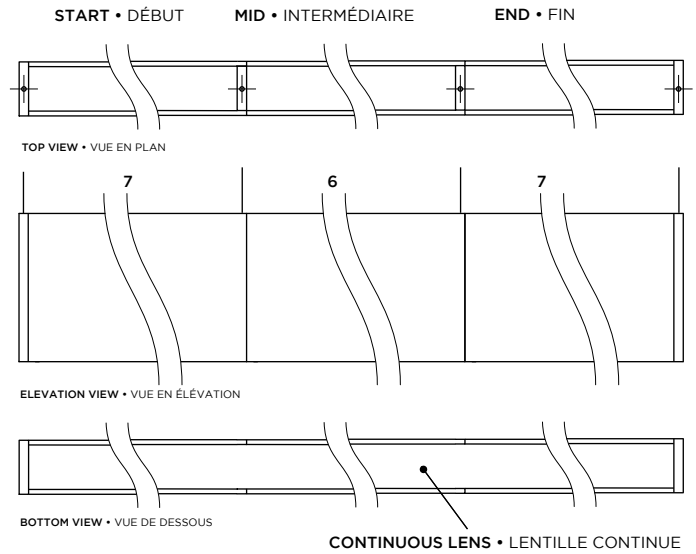

MINI JACK DOUBLE SYSTEM CONFIGURATION TABLE •
TABLEAU DE CONFIGURATION MINI JACK DOUBLE

NOMINAL LENGTH • LONGUEUR NOMINALE	SYSTEM COMPOSITION • COMPOSITION DU SYSTÈME	REAL TOTAL LENGTH • LONGUEUR TOTAL RÉELLE	NOMINAL LENGTH • LON- GUEUR NOMINALE	SYSTEM COMPOSITION • COMPOSITION DU SYSTÈME	REAL TOTAL LENGTH • LONGUEUR TOTAL RÉELLE
9'	4 + 5	9'	29'	7 + 7 + 7 + 8	29'-1/4"
10'	5 + 5	10'	30'	8 + 7 + 8 + 7	30'-1/4"
11'	5 + 6	11'	31'	8 + 8 + 8 + 7	31'-1/4"
12'	6 + 6	12'	32'	8 + 8 + 8 + 8	32'-1/4"
13'	6 + 7	13'	33'	6 + 7 + 7 + 7 + 6	33'-3/8"
14'	7 + 7	14'	34'	7 + 7 + 7 + 7 + 6	34'-3/8"
15'	7 + 8	15'	35'	7 + 7 + 7 + 7 + 7	35'-3/8"
16'	8 + 8	16'	36'	7 + 7 + 8 + 7 + 7	36'-3/8"
17'	5 + 7 + 5	17'-1/8"	37'	8 + 7 + 7 + 7 + 8	37'-3/8"
18'	6 + 6 + 6	18'-1/8"	38'	8 + 7 + 8 + 7 + 8	38'-3/8"
19'	6 + 7 + 6	19'-1/8"	39'	8 + 8 + 8 + 8 + 7	39'-3/8"
20'	7 + 6 + 7	20'-1/8"	40'	8 + 8 + 8 + 8 + 8	40'-3/8"
21'	7 + 7 + 7	21'-1/8"	41'	7 + 7 + 7 + 7 + 7 + 6	41'-1/2"
22'	7 + 8 + 7	22'-1/8"	42'	7 + 7 + 7 + 7 + 7 + 7	42'-1/2"
23'	8 + 7 + 8	23'-1/8"	43'	7 + 7 + 7 + 7 + 7 + 8	43'-1/2"
24'	8 + 8 + 8	24'-1/8"	44'	8 + 7 + 7 + 7 + 7 + 8	44'-1/2"
25'	6 + 6 + 6 + 7	25'-1/4"	45'	8 + 8 + 8 + 7 + 7 + 7	45'-1/2"
26'	6 + 7 + 7 + 6	26'-1/4"	46'	8 + 8 + 7 + 7 + 8 + 8	46'-1/2"
27'	7 + 7 + 7 + 6	27'-1/4"	47'	8 + 8 + 8 + 8 + 8 + 7	47'-1/2"
28'	7 + 7 + 7 + 7	28'-1/4"	48'	8 + 8 + 8 + 8 + 8 + 8	48'-1/2"

